

HORN SPEAKERS

Combination Type Horn Speaker

WT-605N 5w



Combination Type Horn Speaker

WT-610N 10w



Combination Type Horn Speaker

WT-615N 15w



Connections

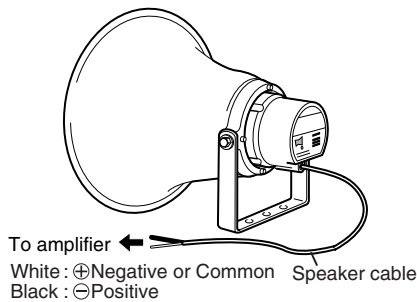

Impedance Selection

Select the desired impedance by inserting a screwdriver into the impedance selector located on the rear of the speaker. The OFF position disconnects the speaker from the amplifier and no sound is output.

WT-605N

(Factory Default: 5 W)

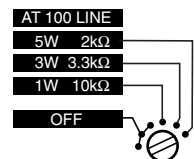

WT-610N

(Factory Default: 10 W)

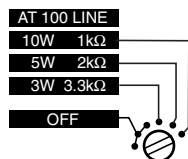

WT-615N

(Factory Default: 15 W)

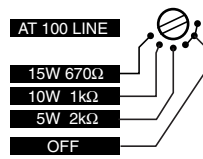

Business Patners :

EUROCOIN SALES & SERVICES SDN. BHD.
(Co No 236371-A)

35, Jalan SS 15/4C, Subang Jaya
47500 Selangor

Tel: 5637 3000 Fax: 5637 1000

E-mail address: info@eurocoin.com.my

Website: www.eurocoin.com.my

Dimensions

WT-605N

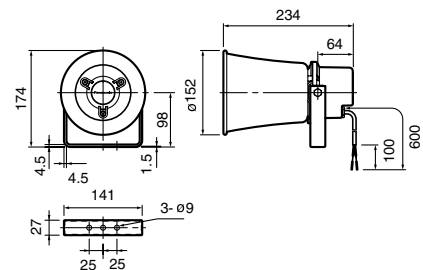

WT-610N

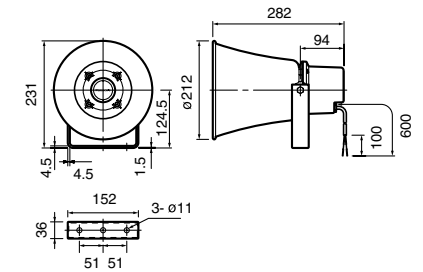

WT-615N

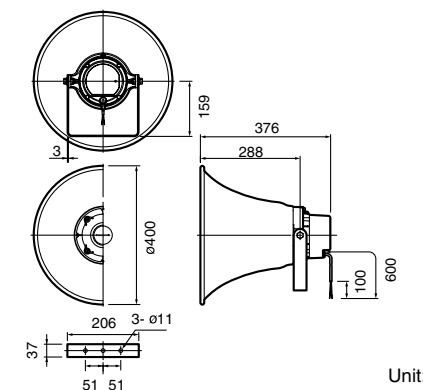

Unit: mm

SPECIFICATIONS

Model No.	WT-605N	WT-610N	WT-615N
Rated Input	5 W	10 W	15 W
Input Impedance	2 kΩ, 3.3 kΩ, 10 kΩ	1 kΩ, 2 kΩ, 3.3 kΩ	670 Ω, 1 kΩ, 2 kΩ
Frequency Response	400 ~ 7,000 Hz	320 ~ 7,000 Hz	250 ~ 6,000 Hz
Sound Pressure Level	104 dB (1 m/ 1 W)	105 dB (1 m/ 1 W)	106 dB (1 m/ 1 W)
Speaker Cable	ø6 mm, 2-core cabtire cable (length 60 cm)		
Dimensions	152 mm (W) x 172 mm (H) x 234 mm (D)	212 mm (W) x 231 mm (H) x 282 mm (D)	ø400 mm x 376 mm (D)
Weight (Approx.)	1.3 kg	1.9 kg	3.9 kg
Finish Horn	Aluminum (Munsell N7)		
Rear Cover	ABS resin (Munsell N4)		

*Refer to the speaker color samples on Page 52.